



### BACK PRESSURE Be. SAFETY VALVES

#### DESCRIPTION

Milton Roy safety valves prevent damage to metering pump systems due to excessive pressure. Undesirable pressure buildup can result from valve closure or other obstructions to flow in the pump discharge piping. Models are available for flow rates to 2400 gph (90841/h). The "H" series is available for pressures up to 1500 psi (105 kg/cm<sup>2</sup>); the "L" series is available for pressures up to 150 psi (10.5 kg/cm<sup>2</sup>).

Milton Roy back pressure valves provide added resistance over and above natural pipe system pressure for the metering pump to work into. Most metering pumps require a discharge pressure at least 40 psi greater than inlet pressure to meter accurately. The valve is designed to provide back pressure only while the pump is running. It will not provide leak tight sealing with the pump shut off. If "anti-siphoning" is needed with the pump shut off, use of a positive shut off valve is recommended. Models are available for flow rates to 2400 gph (90841/h). The "H" series is available with pressures to 200 psi (14 kg/cm<sup>2</sup>); the "L" series is available with pressures to 150 psi (10.5 kg/cm<sup>2</sup>).

#### 1/2" "H" SERIES

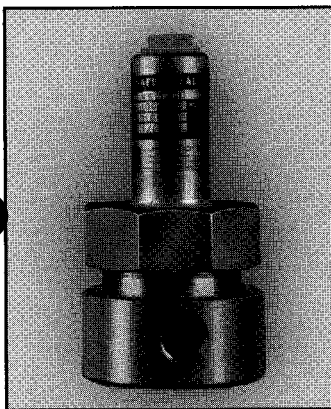

#### 1" "H" SERIES

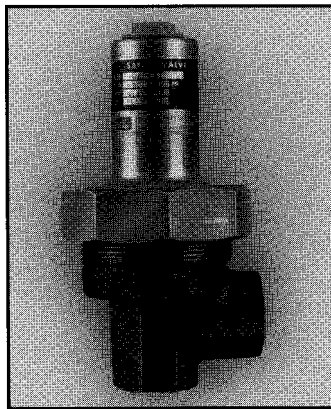

#### "H" SERIES FEATURES

Milton Roy "H" Series valves are available in 0- and 1- with either 316 SS or Alloy 20 wetted parts. Each valve is set at the factory per your specification, but is also field adjustable.

- Externally adjustable pressure setting
- In-line servicing
- PTFE diaphragm isolates spring and other upper body components from contact with process liquid
- Non-chattering, precision mechanism
- Compliance with Hydraulic Institute Standards, API 675 accessory requirements
- Low cost
- One year warranty

#### "H" SERIES PARTS Br. DIMENSIONS

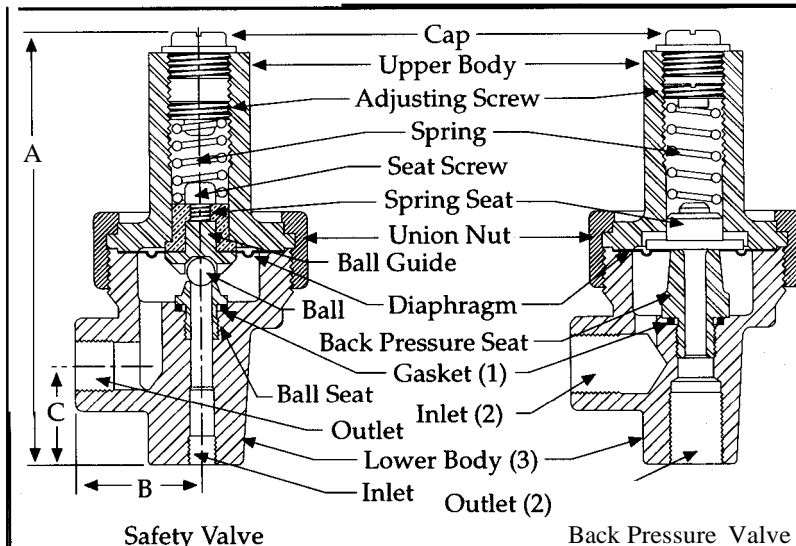

#### NOTES:

1. Gasket is used on 0- size valves only.
2. When using back pressure valves with set pressures above 70 psi (4.9 kg/cm<sup>2</sup>), connections are reversed; i.e., the bottom port of the valve becomes the inlet connection.
3. Lower body appearance varies with valve size.
4. A, B, and C dimensions may differ slightly for some lower body materials of construction.

Valve Size	Inlet/Outlet	A {4}		B {4}		C {4}		Average Shipping Weight (lbs.)
		in	em	in	em	in	em	
	W-14	6.0	15	1.9	5	0.9	2	5
	1"-11 1/2"	8.5	22	2.5	6	1.6	4	12

# Valves

AD 4301  
Effective 1/15/96



# MILTON ROY

## ••H" SERIES TYPICAL INSTALLATION

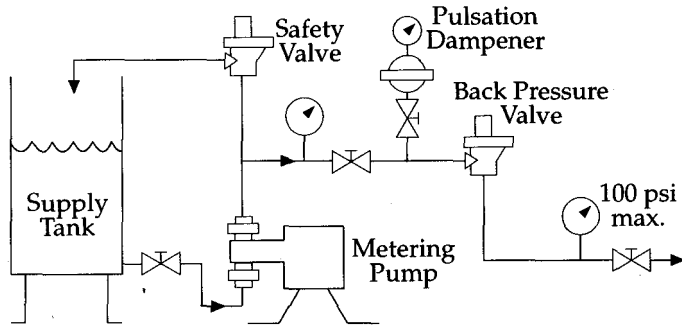

"H" Series safety valves must discharge to atmospheric pressure. Also, use of a pulsation dampener in conjunction with a back pressure valve will result in extended valve life (cycling with each pump stroke is eliminated). Maximum allowable pressure downstream of back pressure valve is 100 psi.

## ••H•• SERIES MATERIALS

Other materials are available for special applications.

Part	316 SS	Alloy 20
Lower Body	316 SS	Alloy 20
Diaphragm	PTFE	PTFE
Seat	316 SS	Alloy 20
<b>Safety Valves Only</b>		
Ball Guide	316 SS	Alloy 20
Ball	316 SS	Alloy 20

## "H" SERIES PRODUCT CODE

**9**      **QJ**

<b>Type</b>	<b>Size</b>	<b>Material of Construction</b>
S = Safety Valve	08=0-	1 = 316SS
B = Back Press. Valve	16 = 1-	5 = Alloy 20

Set Pressure Range			
Safety Valves		Back Press. Valves	
OH	r	OH	1H
2 = 20-49	2 = 20-375	2 = 5-35	2 = 5-35
4 = 50-300	3 = 376-1000	3 = 36-70	3 = 36-70
5 = 301-600		4 = 71-100	4 = 71-125
6 = 601-1200		5 = 101-200	5 = 126-200
7 = 1201-1500			

## "H" SERIES PERFORMANCE CURVES

### Safety Valve Curves

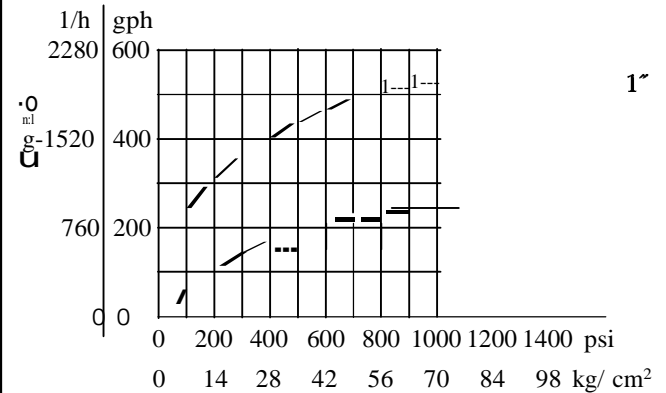
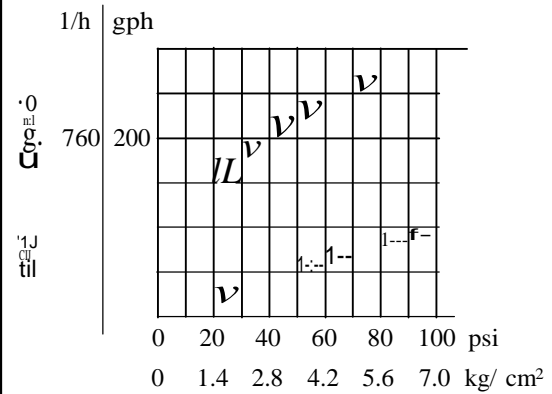

### Back Pressure Valve Curves

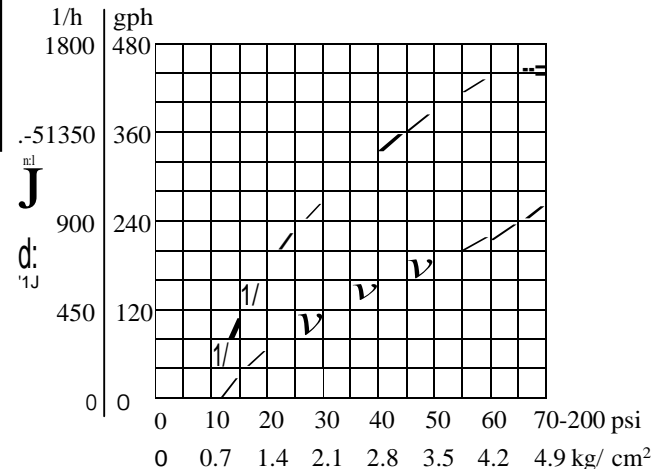



### ••L" SERIES FAMILY



### ••L•• SERIES FEATURES

Milton Roy "L" Series valves are available in  $1/16$ " through 2". Materials of construction include PVC, CPVC, PP, PVDF, PTFE, 316 SS, Alloy 20, and hastelloy C276. Valves are field adjustable, and are factory preset at 50 psi.

- High reliability/low cost
- Robust machined construction
- Vulcanized PFA/EPDM diaphragm
- Externally adjustable from 0 to 150 psi standard
- Ventable to suction line
- Wide range of materials
- Tamper resistant adjustment screw

### ••L•• SERIES PARTS & DIMENSIONS

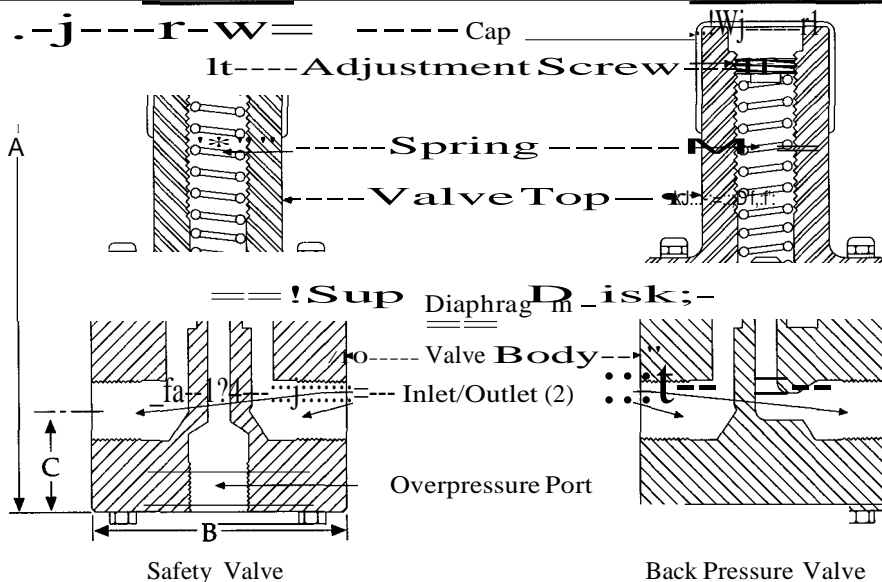

#### NOTES:

1. Max temperature is 110°F for PVC valves and 250°F for 316, Alloy 20, and Hastelloy C276 valves with steel top.
2. Inlet and outlet port are interchangeable on safety valves. Inlet and outlet ports are marked with arrows on the valve body of back pressure valves, and are not interchangeable.

Valve Size	Inlet/Outlet	A (4)		B (4)		C (4)		Avg. Ship. Weight	
		in	em	in	em	in	em	Plastic	Metallic
$1/4$ "	$1/4$ NNPT	3.500	8.890	2.375	6.033	0.750	1.905	1 lb.	2 lbs.
$1/2$ "	$1/2$ NNPT	5.500	13.970	3.500	8.890	1.125	2.858	2lbs.	7 lbs.
$3/4$ "	$3/4$ NNPT	5.500	13.970	3.500	8.890	1.125	2.858	2lbs.	7 lbs.
$1$ "	1" NPT	6.250	15.875	3.500	8.890	1.375	3.493	2lbs.	7 lbs.
1 1/2"	1 1/2" NNPT	9.000	22.860	5.500	13.970	2.250	5.715	8lbs.	28 lbs.
2"	2" NNPT	9.000	22.860	5.500	13.970	2.250	5.175	8lbs.	28 lbs.

# Valves

AD 4301

Effective 2/15/96

## "L" SERIES TYPICAL INSTALLATION

### NOTE:

It is recommended that "L" Series safety valves discharge to atmospheric pressure. Also, use of a pulsation dampener in conjunction with a back pressure valve will result in extended valve life (cycling with each pump stroke is eliminated). Maximum allowable pressure downstream of back pressure valve should not exceed valve rated pressure.

## "L" SERIES MATERIALS

Other materials are available for special applications.

Part	Material of Construction
Daiphragm	PTFE faced EPDM or Viton
Valve Top	Standard: PVC Optional: Steel, 316 SS
Valve Bottom	Choice of PVC, CPVC, PP, PTFE, PVDF, 216 SS, Alloy 20, or Hastalloy C276

## "L" SERIES PERFORMANCE CURVES

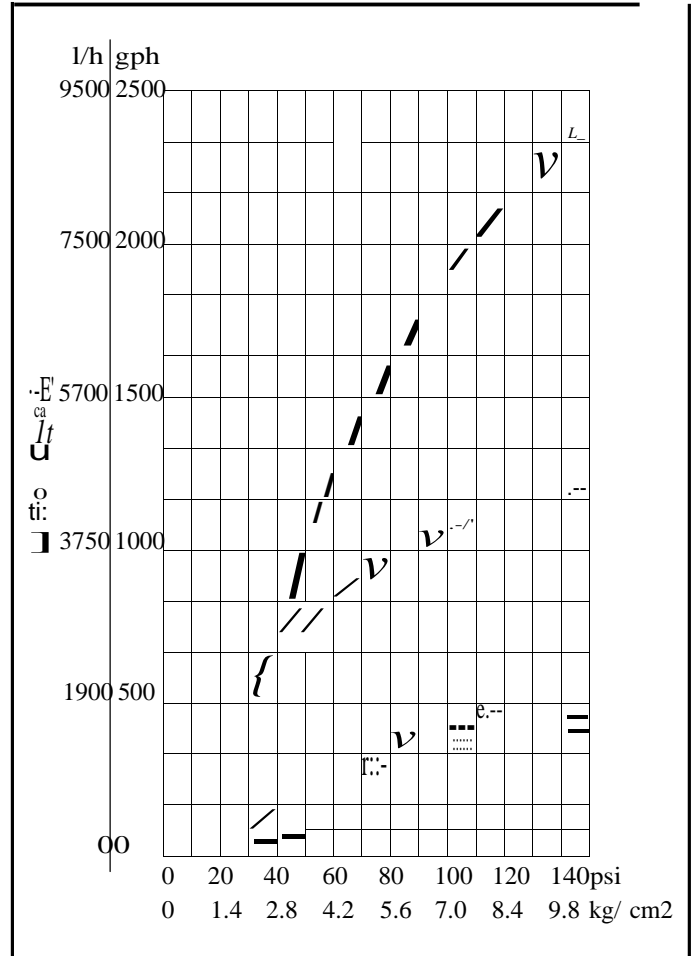

## "L" SERIES PRODUCT CODE

<b>O</b>	<b>QJJ</b>	<b>y</b>
<b>Type</b>	<b>Size</b>	<b>Material of Construction</b>
S = Safety Valve	04 = 0N	1 = 316 SS*
B = Back Press. Valve	08 = YzN	2 = PVC
	12 = %N	5 = Alloy 20*
	16 = r	6 = Hastelloy C
	24 = 10N	C = CPVC
	32 = r	P = Polypropylene
		V = PVDF
		T = PTFE

### NOTE:

\*316 SS and Alloy 20 are not available in YzN and r sizes. Order from the "H" Series valve line.

## AVAILABLE ACCESSORIES

In addition to metering pumps & chemical feed systems, Milton Roy offers the following accessories:

- Calibration Columns
- Pulsation Dampeners
- Gauge Glasses
- Dissolving Baskets
- Valve Actuators
- Pressure Gauges
- Floats
- Tanks
- Traps
- Mixers

*All information contained herein subject to change without notice.*